



WORLDWIDE ELECTRIC MOTOR DATA SHEET



WSS34-18-56CB

HORSEPOWER	3/4
RPM / POLES	1800 / 4
VOLTAGE / PHASE	230 / 460 V / 3
FRAME	56C
ENCLOSURE	TEFC
FREQUENCY	60 HZ
FULL LOAD SPEED	1725 RPM
SERVICE FACTOR	1.15
INSULATION CLASS	F
FULL LOAD AMPS	2.4 / 1.2 A
LOCKED ROTOR AMPS (STARTING)	14.4 / 7.2 A
NO LOAD CURRENT	0.88 / 0.44 A
EFFICIENCY (100% LOAD)	82.5%
POWER FACTOR (100% LOAD)	0.78
DUTY CYCLE	CONTINUOUS
FULL LOAD TORQUE	2.2 LB. FT.
LOCKED ROTOR TORQUE	227%
BREAKDOWN TORQUE	320%
DE BEARING	6205 DDU
ODE BEARING	6205 DDU
MOUNTING	F1
ROTATION	CW / CCW
BASE TYPE	C-FACE - RIGID
SHAFT	KEYED
OVERLOAD	---
START CAPACITOR	---
RUN CAPACITOR	---
WIRE TYPE	LOOSE WIRE
WIRE HOUSING	JUNCTION BOX
ROTOR INERTIA	0.08104 LB. FT. ²
SHAFT MATERIAL	304 STAINLESS STEEL
CONNECTION DIAGRAM	230 / 460 V - 9 LEAD Y
APPROXIMATE WEIGHT	33 LBS.
INVERTER RATING	2:1 CT / 5:1 VT PWM Type





WORLDWIDE ELECTRIC MOTOR DRAWING

WSS34-18-56CB

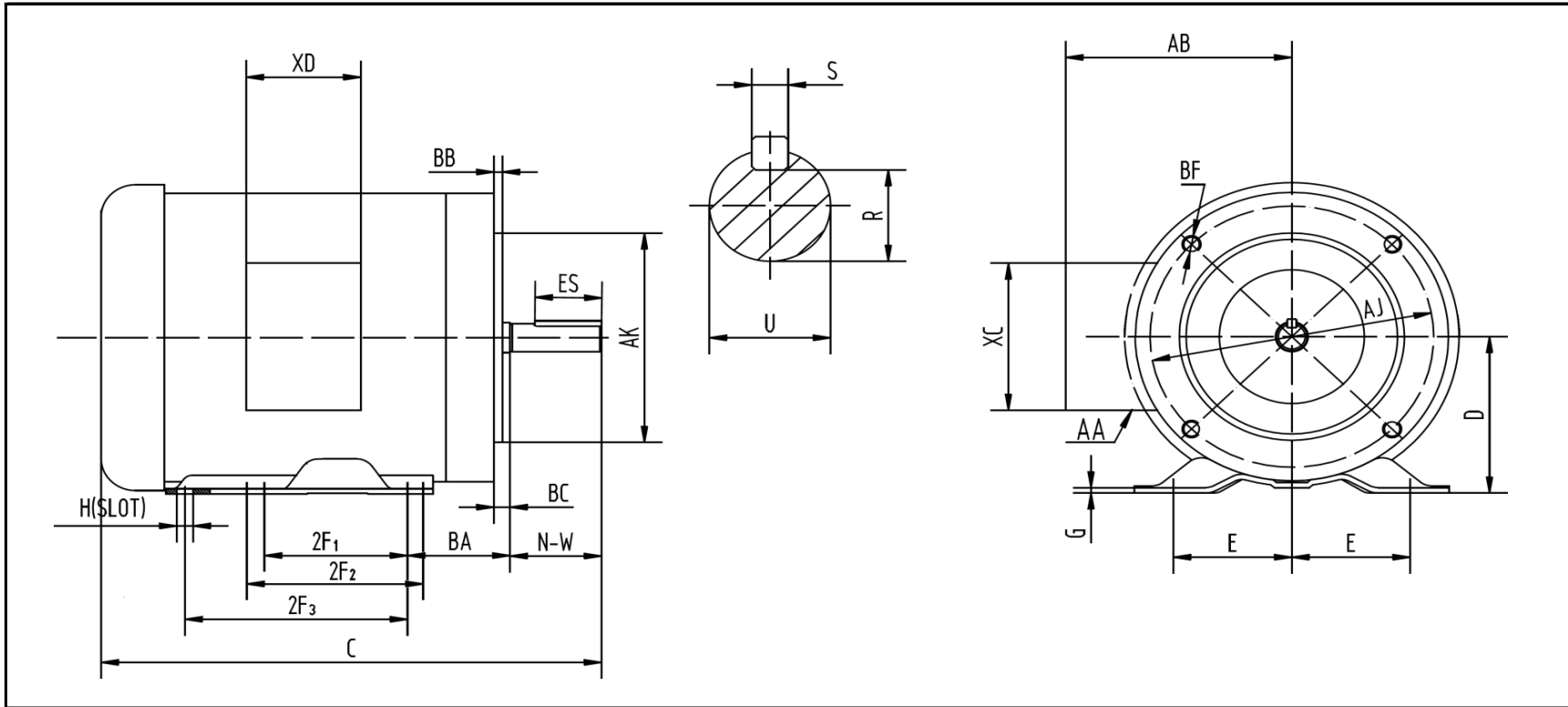

MOUNTING												
E	2F ₁	2F ₂	2F ₃	H	BA	C	D	G	AA	AB	BC	
2.44	3	4	---	0.34	2.75	12.66	3.5	0.12	0.86	5.39	0.19	

KEY		KEYSEAT	FLANGE				SHAFT	TERMINAL BOX		
ES	S	R	AJ	AK	BB	BF	N-W	U	XC	XD
1.41	0.188	0.517	5.875	4.5	0.16	3/8-16	1.88	0.625	4.72	3.82

ALL DIMENSIONS IN INCHES

REVISED - 09/29/15